

SPECIFICATIONS

DIAMETER:	12" (300MM)
SENSITIVITY (2.83V @ 1m):	92dB
POWER HANDLING:	350W _{RMS} (1,400W _{PEAK})
FREQUENCY RESPONSE:	23 ~ 400Hz
NOMINAL IMPEDANCE:	1 or 4 OHMS
VOICE-COIL DIAMETER:	3" (76.2MM)

DIMENSIONS:

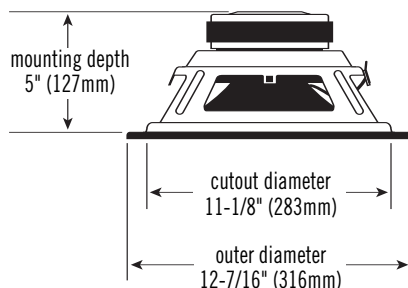

THIELE-SMALL PARAMETERS

VOICE-COIL DC RESISTANCE:	R_{EVC} (OHMS)	1.00
VOICE-COIL INDUCTANCE @ 1kHz:	L_{EVC} (MH)	0.76
DRIVER RADIATING AREA:	S_D (IN ²)	82.15
	S_D (CM ²)	530.00
MOTOR FORCE FACTOR:	BL (TM)	8.52
COMPLIANCE VOLUME:	V_{AS} (FT ³)	3.47
	V_{AS} (LITERS)	98.30
SUSPENSION COMPLIANCE:	C_{MS} (µM/N)	245.00
MOVING MASS, AIR LOAD:	M_{MS} (GRAMS)	243.00
MOVING MASS, DIAPHRAGM:	M_{MD} (GRAMS)	236.00
FREE-AIR RESONANCE:	F_S (Hz)	20.60
MECHANICAL Q:	Q_{MS}	7.35
ELECTRICAL Q:	Q_{ES}	0.49
TOTAL Q:	Q_{TS}	0.456
MAGNETIC-GAP HEIGHT:	H_{AG} (IN)	5/16
	H_{AG} (MM)	8.00
VOICE-COIL HEIGHT:	H_{VC} (IN)	1-1/2
	H_{VC} (MM)	32.00
MAXIMUM EXCURSION:	X_{MAX} (IN)	1/2
	X_{MAX} (MM)	12.00

SEALED-ENCLOSURE VOLUME (INCLUDES DRIVER DISPLACEMENT)

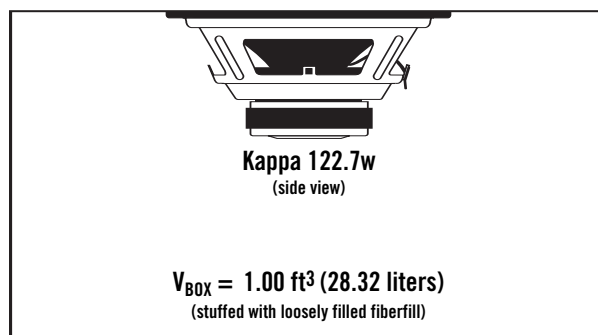

SEALED-ENCLOSURE FREQUENCY RESPONSE @ 2.83V

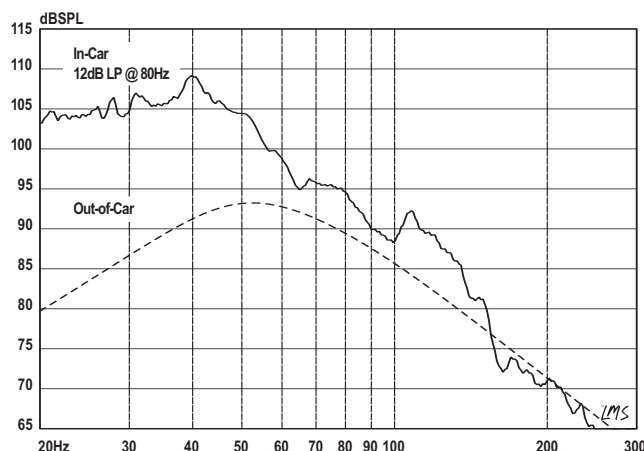

SEALED-ENCLOSURE TRANSDUCER EXCURSION @ 350W

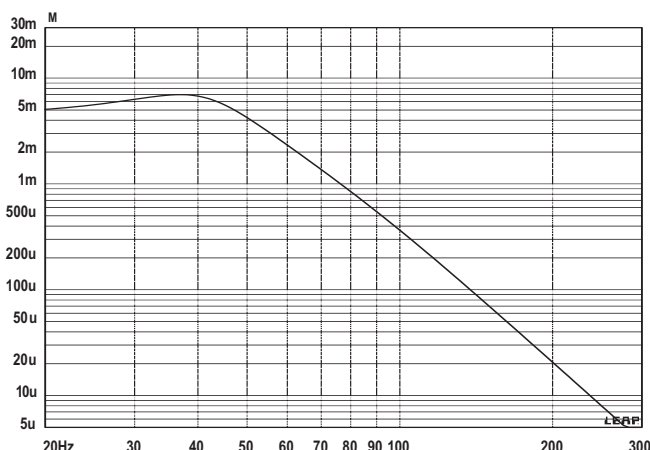

VENTED-ENCLOSURE VOLUME (INCLUDES DRIVER DISPLACEMENT)

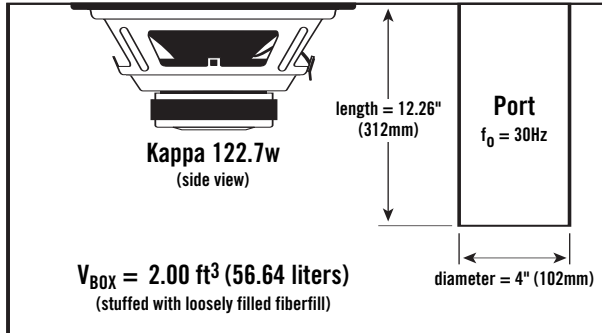

BAND-PASS-ENCLOSURE VOLUME (INCLUDES DRIVER DISPLACEMENT)

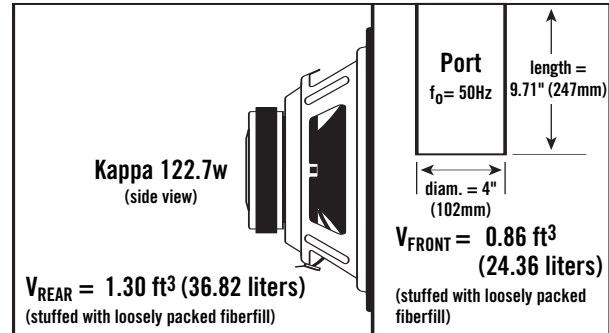

VENTED-ENCLOSURE FREQUENCY RESPONSE @ 2.83V

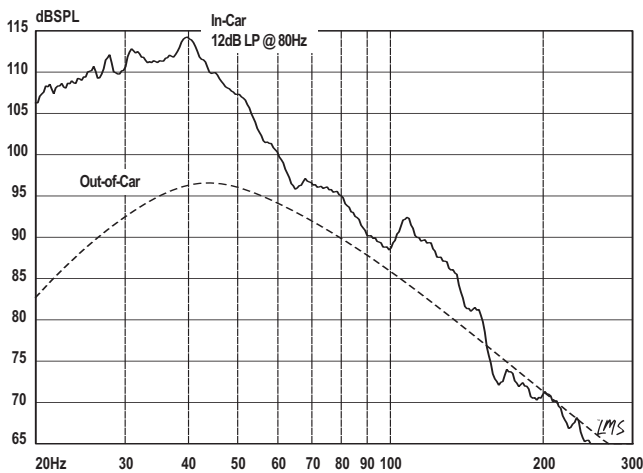

BAND-PASS-ENCLOSURE FREQUENCY RESPONSE @ 2.83V

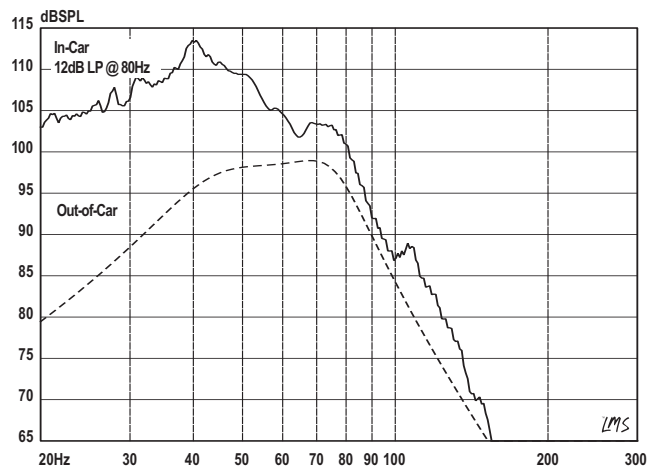

VENTED-ENCLOSURE TRANSDUCER EXCURSION @ 350W

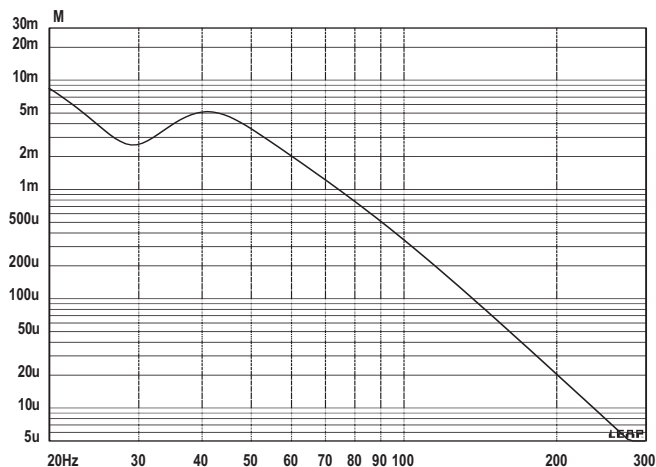

BAND-PASS-ENCLOSURE TRANSDUCER EXCURSION @ 350W

